

Gas burner

Burner size 4 | Heat release 80 ... 800 kW



Hegwein gas burners

Hegwein offers burner solutions for industrial use in accordance with currently applicable regulations and on the basis of technical expertise gained from more than 70 years of experience. Flexible product variants make it possible to configure burners suitable for a wide range of industrial applications. Both standard devices and customised and application-specific special solutions guarantee a high degree of quality.

Features

- **Compact modular design**
 - Integrated spark transformer, flame monitor or burner control unit
 - Reliable spare parts availability
 - Optimal electromagnetic compatibility
 - Straightforward installation and commissioning
 - Various burner series with different options available
- **Flexible operating mode**
 - 1-stage, multi-stage or modulating operation
 - High turn down ratio
- **Explosion protection**
 - Zone 1/21 and Zone 2/22 (ATEX, IECEx, FM-Ex)
- **Approvals***
DVGW, AGA, FM, EAC, SIL2/3 and cULus
- **Customised versions on request**

Benefits

- **High availability**
 - Highest operational and functional reliability
 - Electrical and mechanical components can be replaced separately
- **Flexible burner design**
 - Customer-specific/plant-specific solutions
 - Fuel flexibility
 - Optical flame monitor can be integrated
 - Configurable flame monitor safety time
 - High degree of protection for different ambient conditions
 - Standard tube lengths from 240 to 4000 mm (available in 10 mm increments)
 - Broad range of applications in industrial combustion technology, e.g. in chemical, petrochemical and thermal process plants, as well as in power plants

Gas burners | all sizes

Heat release (kW)	15	35	85	200	350	800	2000	3200	4500
Flame length (mm)	200	250	300	400 ... 500	600 ... 1000	300 ... 2500	300 ... 3000	300 ... 3000	300 ... 3000
Tube diameter (mm)	35	50	70	90	135	160	220	275	327
Burner size	P	0	1	2	3	4	5	6	7

Gas burners | all series

BG	No electrical components integrated
BT	Integrated spark transformer
BA	Integrated spark transformer and flame monitor for intermittent operation
BDA	Integrated spark transformer and flame monitor for continuous operation
BR	Integrated spark transformer and burner control unit for intermittent operation
BD	Integrated spark transformer and burner control unit for continuous operation
GB6/7	Integrated ignition burner and ionisation flame monitor (optional optical flame monitoring)

* Approval of integrated flame monitor

Technical data | gas burner 4 | 80 ... 800 kW

Nominal heat release	800 kW
Flame length	300 ... 2500 mm
Outer tube diameter	Ø 160 mm
Outer tube length	240 ... 4000 mm
Turn down ratio	1:10
Gas port	Rp 2, top or bottom
Air port	DN 100/PN 6, can be rotated by 4 x 90°

Ambient temperature	-30 ... +60 °C (standard) -40 ... +80 °C (special version)
Protection rating	IP 54 (standard) IP 65 (special version)
Supply voltage	230 VAC (standard) 115/125/250 VAC (special version)
Gas operating pressure	80 mbar
Air operating pressure	40 mbar
Gas volume flow (V_n)	80 m ³ /h
Air volume flow (V_n)	900 m ³ /h

Standard specifications for natural gas, standard conditions and an outer tube length of 1 m

Gas burner size 4 | series BA, BDA, BR, BD | side view

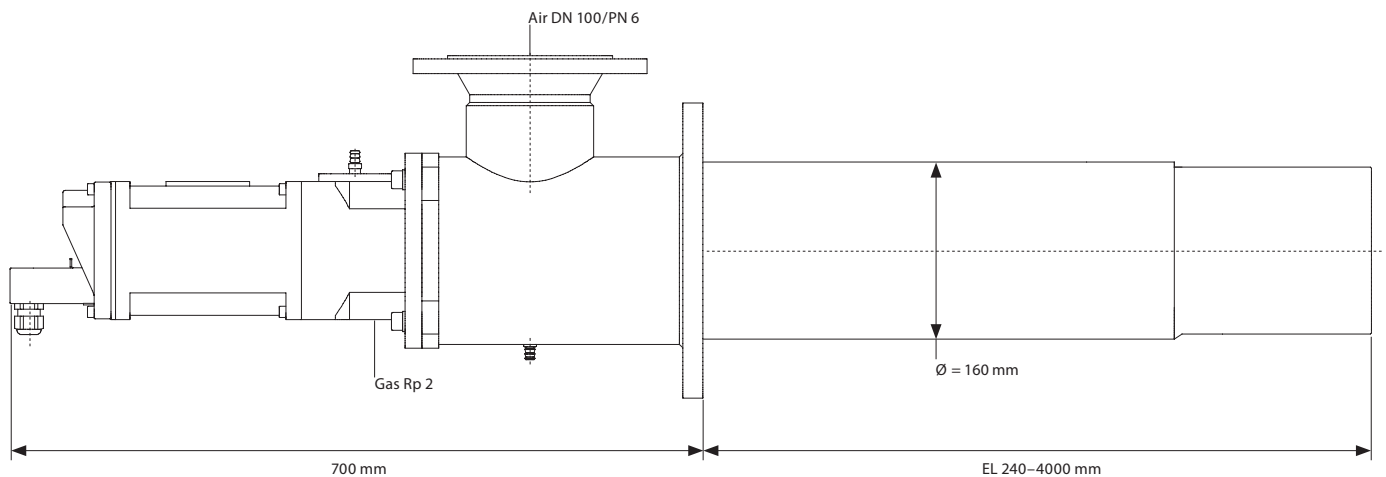

Mounting flange

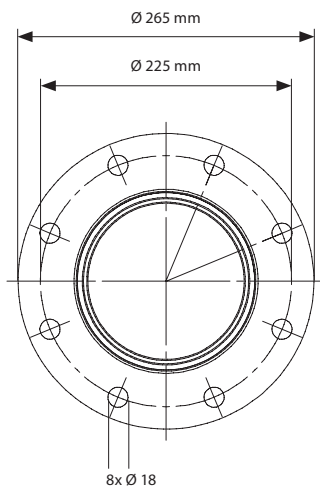

Dimensions may vary slightly depending on specific version

Hegwein GmbH

Kornwestheimer Strasse 47
70825 Korntal-Münchingen, Germany
Phone +49 7150 3830-0
Fax +49 7150 3830-405
info@hegwein.durag.com

www.durag.com